



PERIPHERAL INTERVENTION

COMPLETE PROCEDURAL SOLUTIONS



COMPLETE PROCEDURAL
SOLUTIONS

PROCEDURAL TRAYS, PACKS & KITS

Biopsy Centesis Kits	101
Medication Delivery Pack 1	102
Medication Delivery Pack 2	102
Myelogram Tray	103
Vein Closure Tray	104
Vein Closure Syringe	104
Patient Cover	105
Drape Armour® - Scatter Radiation Drapes	105

SAFETY & WASTE MANAGEMENT

Merit Disposal Depot™ Waste Bags	106-108
----------------------------------	---------

HAEMOSTASIS ACCESSORIES

Clo-Sur P.A.D.® & Clo-Sur PLUS P.A.D.™	109
Haemostasis Valve Adapter	109
SafeGuard® Pressure Assisted Device	110

BIOPSY CENTESIS KITS

BIOPSY/CENTESIS - COMPLETE KIT

The complete kit is designed to provide many of the products needed for biopsy procedures.

Includes

Quantity	Description
1	Lidocaine, 2% 20 mL MDV (plastic)
1	Bandage, 0.75" x 3" Sheer
1	Medallion® Syringe 10 mL L/L
1	Medallion Syringe 20 mL L/L
1	Safety Needle 25G x 1.5"
1	ChloraPrep®, 3 mL Tinted/Orange
1	Ruler, 6"
1	Drape, 22" x 22" w/3.5" Fenestration & Ripline
1	Tray, 3-Compartment
1	ShortStop® Temporary Sharps Holder
1	#11 Futura® Safety Scalpel
1	Safety Needle 18G x 1.5"
1	Towel
1	Lidocaine, Label, 0.5 x 1.75
10	Sponge Gauzes 4" X 4" 12 ply

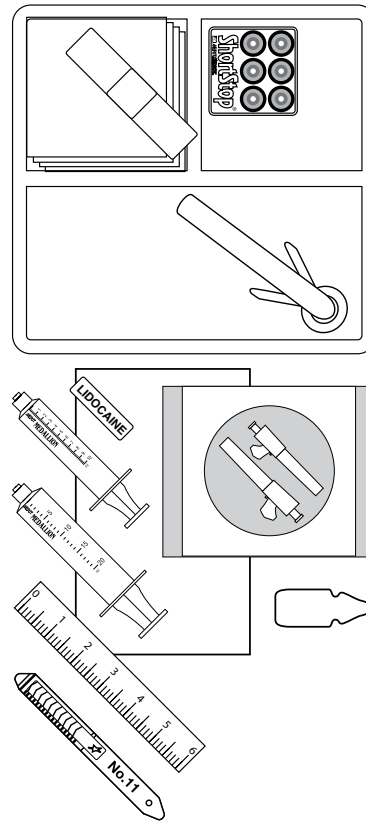

Packaged 10 per case.

Catalogue Number K12T-04322

BIOPSY/CENTESIS - BASIC KIT

The basic kit is designed to provide commonly used products needed for biopsy procedures.

Includes

Quantity	Description
1	Bandage, 0.75" x 3"
1	Medallion® Syringe 10 mL L/L
1	Medallion Syringe 20 mL L/L
1	ChloraPrep®, 3 mL Tinted/Orange
1	Drape, 22" x 22" w/3.5" Fenestration & Ripline
1	Tray, 9" x 5" x 1"
1	Safety Needle 22G x 1.5"
1	Safety Needle 18G x 1"
1	Label, Lidocaine (blue)
10	Sponge Gauzes 4" X 4" 12 ply

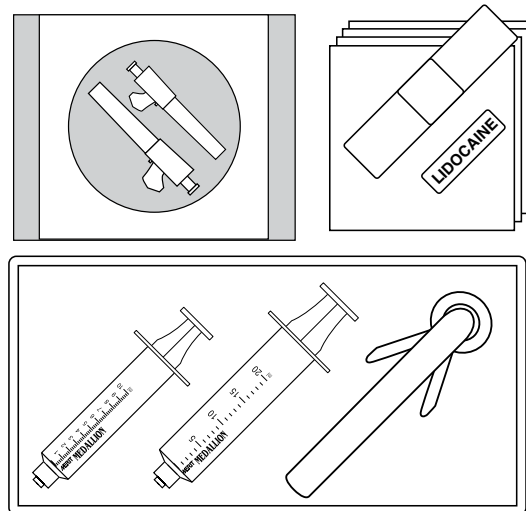

Packaged 30 per case.

Catalogue Number K12T-04321

Biopsy Centesis Kits do not have CE Marking.
ChloraPrep® is a registered trademark of CareFusion 2200, Inc.

MEDICATION DELIVERY PACK 1

Includes

Quantity	Description
----------	-------------

1	Marquis® Series Stopcock 3-Way, Rotator, 500 PSI
1	PAL™ (Pen and Labels) Blank Label Set of 12
1	Ultra Fine Point Permanent Marker
1	250 mL Solution Bowl
1	Tray 9" x 10" x 2"
1	Table Cover 44" x 78"
1	3-Way Metal Stopcock
2	Syringes (Glass) 10 mL L/L
3	Syringes (Glass) 5 mL L/L
1	Half Drape 44"x 55"

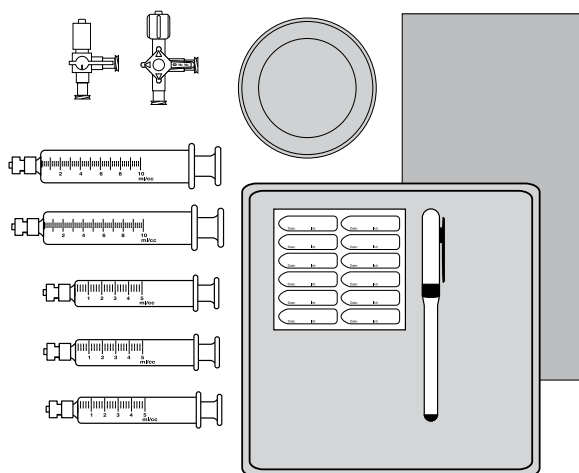

Packaged 6 per case.

Catalogue Number K12T-02843

MEDICATION DELIVERY PACK 2

Includes

Quantity	Description
----------	-------------

1	250 mL Solution Bowl
1	Table Cover 44" x 78"
1	Ultra Fine Point Permanent Marker
3	Medallion® Syringes, 3 mL, L/L, Red with Frosted Cliché
2	Medallion Syringes, 10 mL, L/L, Yellow with Frosted Cliché
1	Marquis® Series Stopcock 3-Way, Rotator, 500 PSI
1	3-Way Metal Stopcock
1	Half Drape 44" x 55"

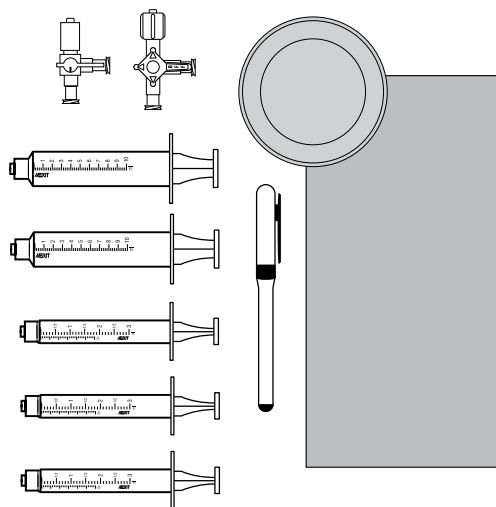

Packaged 6 per case.

Catalogue Number K12T-02844

Medication Delivery Packs do not have CE Marking.

MYELOGRAM TRAY

The tray is designed with all the necessary components to streamline myelogram procedures. Components are strategically placed in a clear form-fitted tray for easy access.

Includes

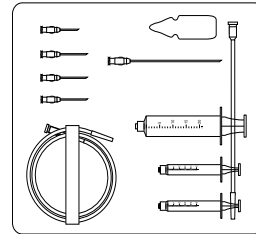

Quantity Description

1	Lidocaine, 1% 5 mL
1	3 Swabsticks Package, PVP Solution
1	Bandage, 0.75" x 3"
2	Syringes 5 mL, L/L
1	Syringe 20 mL, L/L
2	Needles 19G x 1.5" Filtered
1	Needle 22G x 1.5"
1	Needle 25G x.625"
1	Needle, Spinal 22 G x 3.5"
2	Towels, 17" x 19" White
1	Fenestrated Drape w/Adhesive 18" x 26"
5	Sponges, Gauze 3" x 3" (12 Ply)
1	Tubing Set 20" M/F L/S
1	Tubing Set 6" M/F L/S
3	Transport Tubes 10 mL
3	Specimen Labels (White)

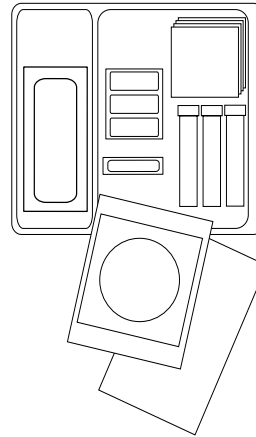

Packaged 10 per case.

Catalogue Number K12T-02045

Myelogram tray does not have CE Marking.

VEIN CLOSURE TRAY

A convenient tray designed to streamline vein closure procedures, improve efficiency, and save money.

Includes

Quantity	Description
1	Band Bag 50" x 50"
1	BD Syringe 5 mL L/L
1	BD Syringe 10 mL L/L
1	BD Syringe 20 mL L/L
1	BD Syringe 3 mL L/L
1	Needle 18G x 1.5"
1	Needle 20G x 1.5"
1	Needle 22G x 1.5"
1	Needle 25G x 1.5"
1	#11 Futura® Safety Scalpel
1	Clear Setup Cover 44" x 77"
1	Skin Marker
1	Bowl 8oz, 250 mL
1	Bowl 16oz, 500 mL
1	Bowl 32oz, 1000 mL
1	Tray 9" x 5" x 2"
1	Probe Cover 6" x 48" w/Gel
1	Steri Strip .5" x 4", 3's
2	Aquasonic Gels 20 mg
1	White Polylined Drape 18" x 26"
1	Curved Forceps Mosq. 5"
40	4" x 4" Gauze Pads (12 Ply)
4	Cloth Towels (Blue)
1	XL Shoe Covers (Pair)
2	Towel Clamps
3	Sponge Sticks 6"
1	XL (NRF) Gown
1	Table Cover 44" x 78"
1	Split Drape 77" x 117", 3.5" x 43"
1	Half Drape 44" x 55"
1	Vein Closure Syringe
1	ShortStop® Sharps Holder
1	Fluid Administration Set 108" Drip Pack

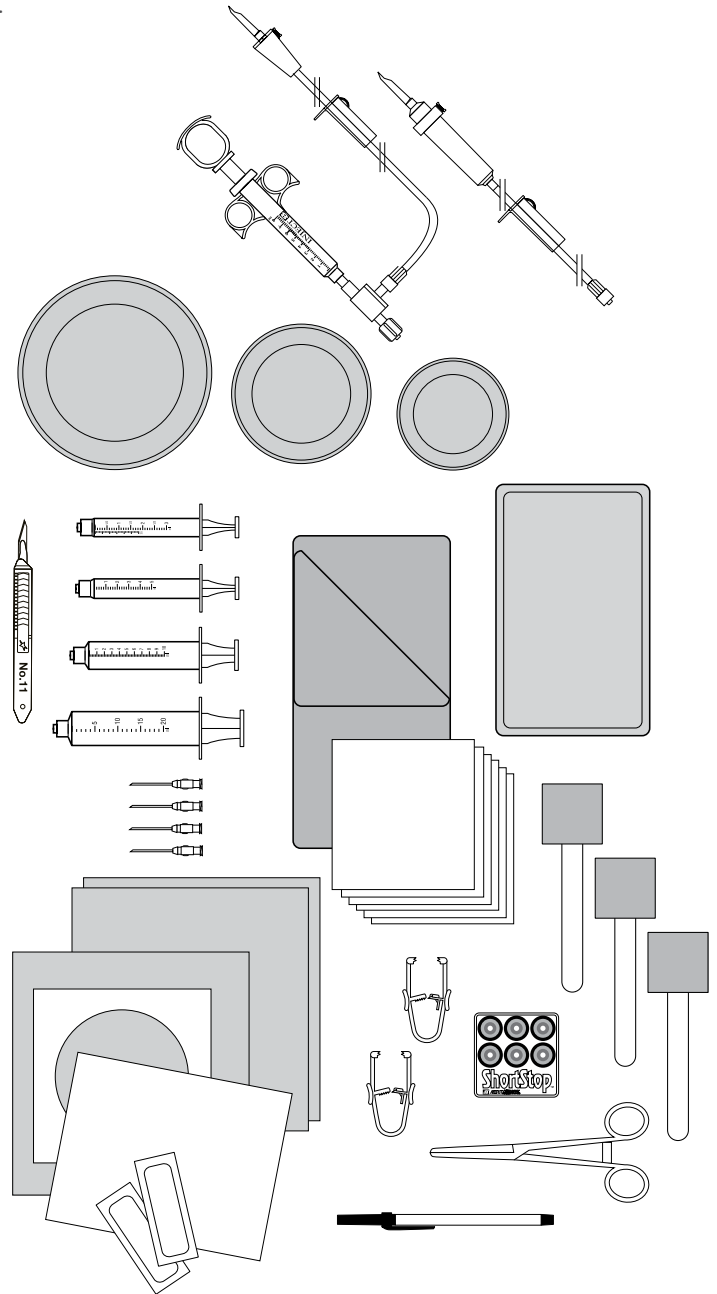

Packaged 3 per case.

Catalogue Number K12T-01822

VEIN CLOSURE SYRINGE

This proprietary valved system allows for controlled delivery with less hand fatigue.

Packaged 15 per box, 60 per case.

Catalogue Number K12-01575

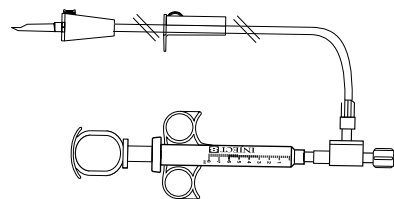

PATIENT COVER

The Patient Cover is a standalone convenience product that Merit Medical has made available for clinical settings where a fenestrated drape outside of the procedure pack is necessary or desired.

Packaged 10 per case.

Catalogue Number K12T-06756

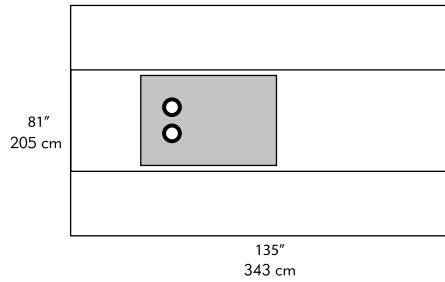

DRAPE ARMOUR® - SCATTER RADIATION DRAPES

These positional protection shields are designed to protect at the procedure site where scatter radiation is most prevalent. They can help protect surgeons and other members of the clinical staff, and offer substantial attenuation as demonstrated by direct beam studies.

Catalogue

Number	Description
K12T-07302	16 x 10 Radiation Pad
K12T-07303	16 x 14 Radiation Pad
K12T-07304	16 x 16 Radiation Pad
K12T-07362	16 x 10 Radiation Pad LOW
K12T-07363	16 x 14 Radiation Pad LOW
K12T-07364	16 x 16 Radiation Pad LOW
K12T-07361	16 x 13 x 9 "L" Radiation Pad

Packaged 10 per case.

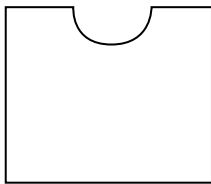
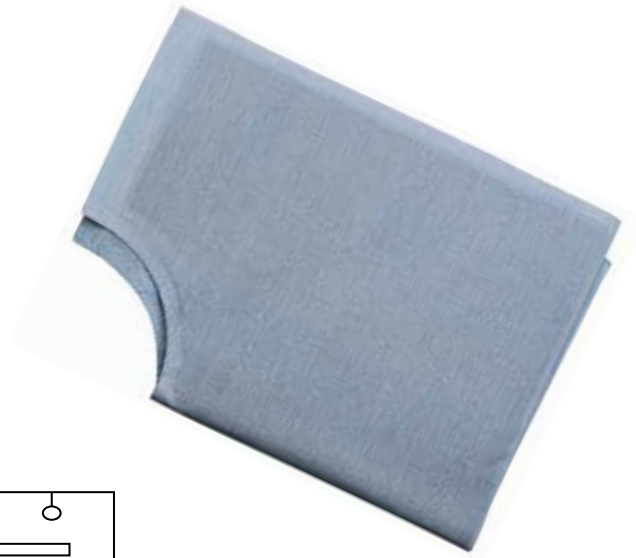

K12T-07302

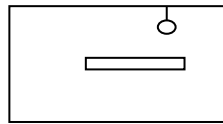

K12T-07303

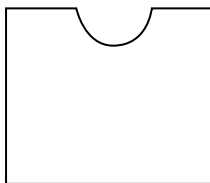

K12T-07362

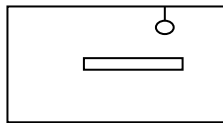

K12T-07363

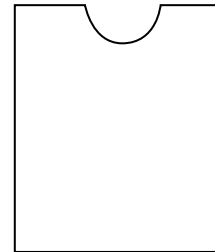

K12T-07304

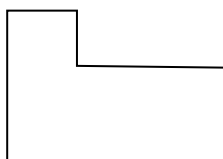

K12T-07361

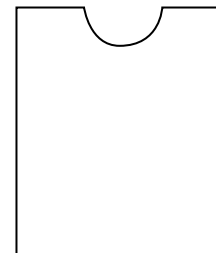

K12T-07364

Drapes Armour® - Scatter Radiation Drapes do not have CE Marking.
Drape Armour is a registered trademark of Microtek Medical, Inc.

MERIT DISPOSAL DEPOT™ WASTE BAGS

Available in many configurations, the Merit Disposal Depot waste bags fully contain fluid waste for easy disposal.

Clear 1400 mL PVC bag, 72" (183 cm) large bore tubing and fixed male Luer. Packaged 20 units per box, 4 boxes per case.

Catalogue Number MDD100



Clear 1400 mL PVC bag, 72" (183 cm) large bore tubing, drape clip and one-way check valve with female Luer. Packaged 20 units per box, 4 boxes per case.

Catalogue Number MDD110

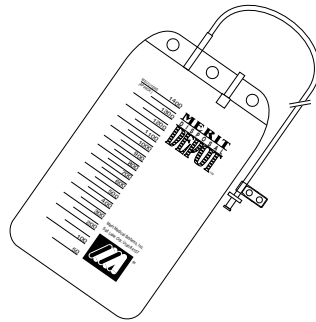

Clear 1400 mL PVC bag, 48" (122 cm) large bore tubing and drape clip. Includes check relief valve with female Luer and a fluid administration set with 72" (183 cm) large bore tubing, roller clamp and user selectable vented spike. Packaged 20 units per box, 4 boxes per case.

Catalogue Number MDD220 (With optional reflux valve)

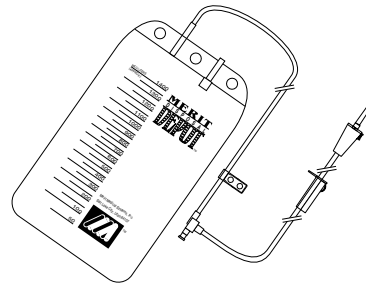

Clear 1400 mL PVC bag, 48" (122 cm) large bore tubing and drape clip. Includes check relief valve with female Luer and a fluid administration set with 72" (183 cm) large bore tubing, roller clamp and user selectable vented spike. Packaged 20 units per box, 4 boxes per case.

Catalogue Number MDD200H
MDD220H (With optional reflux valve)

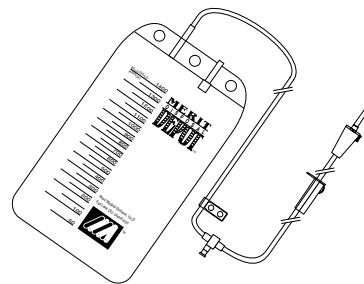

Clear 1400 mL PVC bag and 48" (122 cm) large bore tubing. Includes check relief valve with rotating Luer and a fluid administration set with 72" (183 cm) large bore tubing, roller clamp and user-selectable vented spike. Packaged 20 units per box, 4 boxes per case.

Catalogue Number MDD300H

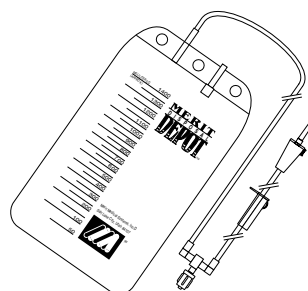

MERIT DISPOSAL DEPOT™ WASTE BAGS

Clear 1400 mL PVC bag and 48" (122 cm) large bore tubing. Includes check relief valve with rotating Luer and a fluid administration set with 72" (183 cm) small bore tubing, roller clamp and user-selectable vented drip chamber with micro filter. Packaged 20 units per box, 4 boxes per case.

Catalogue Number MDD400H



Clear 1400 mL PVC bag, 48" (122 cm) large bore tubing and drape clip. Includes check relief valve and standard pressure 3-way Marquis® Stopcock, two fluid administration sets with 72" (183 cm) large bore tubing (green striped contrast line), roller clamps and user-selectable vented spikes. Packaged 20 units per box, 4 boxes per case.

Catalogue Number MDD500H
MDD520H (With optional reflux valve)

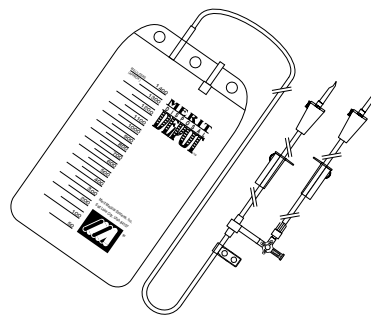

Clear 1400 mL PVC bag, 48" (122 cm) large bore tubing and drape clip. Includes check relief valve, standard pressure 3-way Marquis® Stopcock, one fluid administration set with 72" (183 cm) large bore tubing, roller clamp and user-selectable vented spike. Also includes a bonded Miser® Contrast Management System. Packaged 4 units per box, 4 boxes per case.

Catalogue Number K10-00576



MERIT DISPOSAL DEPOT® WASTE BAGS

Clear 1400 mL PVC bag, 48" (122 cm) large bore tubing and drape clip. Includes check relief valve, standard pressure 3-way Marquis® Stopcock, one fluid administration set with 72" (183 cm) large bore tubing, roller clamp and user-selectable vented spike. Also includes a bonded In-Line Contrast Management System (CMS). Packaged 8 units per box, 4 boxes per case.

Catalogue Number K10-00577

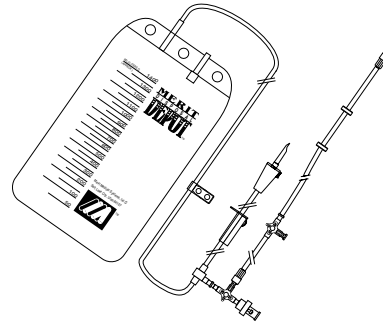

Clear 1400 mL PVC bag, 12" (30.5 cm) bifurcated large bore tubing, (right) 60" (152 cm) large bore tubing with check relief valve and male rotating Luer, (left) 60" (152 cm) large bore peel-away tubing with check relief valve, female Luer reflux valve and drape clip. Both lines connect to 12" (30.5 cm) large bore FAS line with roller clamp and user-selectable vented spike. Packaged 15 units per box, 4 boxes per case.

Catalogue Number K10-01103



Clear 1400 mL PVC bag, 48" (122 cm) large bore tubing and drape clip. Includes check relief valve with female Luer and 15" (38 cm) large bore tubing, and fixed male Luer. Packaged 20 units per box, 4 boxes per case.

Catalogue Number K10-01555

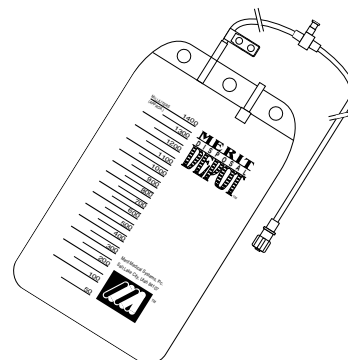

CLO-SUR P.A.D.[®] & CLO-SUR PLUS P.A.D.[™]

Clo-Sur P.A.D. and Clo-Sur ^{PLUS} P.A.D. are non-woven topical pads made with a proprietary polyprolate, a positively-charged material that reacts with negatively-charged red blood cells to accelerate clotting. The Clo-Sur P.A.D. promotes haemostasis and the Clo-Sur ^{PLUS} P.A.D. promotes haemostasis and is an antimicrobial barrier. Packaged 10 units per box.

Catalogue Number	Description
MVP44	4cm x 4cm Clo-Sur P.A.D. Haemostasis Dressing
SCV22P-AB	4cm x 4cm Clo-Sur ^{PLUS} P.A.D. Haemostasis Dressing/Antimicrobial Barrier
HPAD22	SCV22P-AB with 3M [™] Tegaderm [™] Transparent Film*

* 3M and Tegaderm are trademarks of 3M.



HAEMOSTASIS VALVE ADAPTER

Minimises blood loss during the introduction of catheters or devices into the vasculature. Provides a side arm and three way stopcock to facilitate aspiration or infusion. May be used with devices that are 8F or smaller. Packaged 10 per box.

Catalogue Number HVA-100



SAFEGUARD® PRESSURE ASSISTED DEVICE

The SafeGuard pressure assisted device delivers passive compression and enables immediate pressure adjustment. It also maintains consistent pressure on the site when obtaining haemostasis with manual compression, and during patient recovery, positioning and transport. The SafeGuard pressure assisted device reduces demands on the clinical staff, maximises valuable resources, and enhances patient comfort.



Catalogue Number	Size	Description
82000	24 cm	SafeGuard Pressure Assisted Device (Outside US)
82000D	24 cm	SafeGuard Pressure Assisted Device (US Only)
82050	12 cm	SafeGuard Pressure Assisted Device
0684-00-0504	24 cm	SafeGuard Pressure Assisted Device (Japan Only)

Packaged 10 units per box.